

Article number: 12309000040100  
Description: KLEE-coil 309 000 040.100  
M4 Unhardened steel

## Measures

---

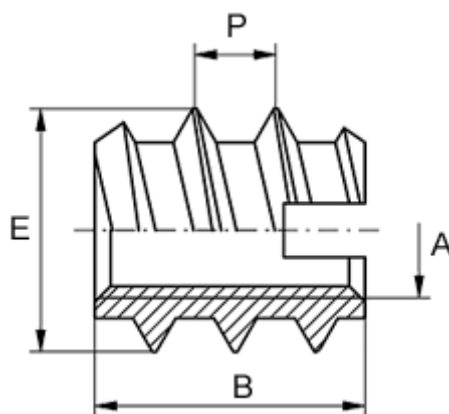

Female thread A	= M4
Length B	= 10
Male thread E	= 7.0
Min hole depth	= 13
Recommended bore diameter (plastic/hard wood)	= 5.2 to 5.3
Recommended bore diameter, soft wood (largest)	= 5.0
Thread pitch P	= 3.0